

SNV-M

straight, metric, metal thread, swivel 直型, 公制, 金属螺纹, 旋转管接头

For applications with high technical requirements. 应用于高技术要求。

IP66/IP68

- Fitting body: high-grade, specially formulated polyamide 6
管接头: 高级, 特殊改良聚酰胺6制成
- Thread: nickel-plated brass
螺纹: 黄铜镀镍
- Very high impact resistance
非常高的抗冲击强度
- High conduit pull-out strength
高强度的抗拉能力
- High thread and system connection strength
高强度的螺纹和系统连接
- Vibration-proof connection to PMA conduits
配合PMA软管使用具有很好的防震作用
- Suitable for occasional rotation; Easy installation
适用于偶然的旋转; 易于安装
- Very good chemical properties
非常好的化学性能
- Free from halogens and cadmium; RoHS and REACH compliant
不含卤素和镉; RoHS 和 REACH 合规性
- Very good UV resistance and weathering characteristics
非常好的抗紫外线和耐候性能
- EN 45545-2 HL3 (R22 & R23)
HL3, 根据EN45545-2车内软管R22/车外软管R23标准
- NFPA 130
NFPA 130
- UL 94 (V0); UL 1696 (UL File E80294)
UL 94 (V0); UL 1696 (UL 文件 E80294)
- Fits both conduit profiles-fine (T) and coarse (G)
适用软管类型-细波纹 (T) 和粗波纹 (G)
- Temperature range: -50°C to +105°C; short-term: +160°C
温度范围: -50°C 至 +105°C; 短期温度: +160°C
- Content of delivery: fitting with oval clips (OVN2), conduit and thread gasket (NVN3, SVN4 and OR)
包装配件: 管接头和椭圆形夹子 (OVN2), 软管和螺纹密封圈 (NVN3, SVN4 和 OR)

Order No. black 订货号 黑色	Thread metric 螺纹 公制	Conduit size 软管规格 NW 标称内径 (mm)	Dimensions 尺寸			Packing unit 包装量 (pcs/PU)	MOQ 最小起订量 (pcs)
			g (mm)	L (mm)	d2 (mm)		
# NSNV - M120 - 10	M12 x 1.5	10	10.0	50.5	20.0	1	10
# NSNV - M162 - 10	M16 x 1.5	12	10.0	53.5	23.5	1	10
# NSNV - M207 - 10	M20 x 1.5	17	10.0	62.5	29.5	1	10
# NSNV - M253 - 11	M25 x 1.5	23	11.0	67.5	37.0	1	10
# NSNV - M329 - 13	M32 x 1.5	29	13.0	72.0	44.0	1	10
# NSNV - M329 - 7	M32 x 1.5	29	7.0	66.0	44.0	1	10
# NSNV - M406 - 13	M40 x 1.5	36	13.0	85.5	53.5	1	10
# NSNV - M406 - 7	M40 x 1.5	36	7.0	79.5	53.5	1	10
# NSNV - M409 - 13	M40 x 1.5	29	13.0	72.0	44.0	1	10
# NSNV - M508 - 14	M50 x 1.5	48	14.0	87.5	66.0	1	10
# NSNV - M638 - 14	M63 x 1.5	48	14.0	84.0	66.0	1	10

标记为 # 的产品有最小起订量 (MOQ)

The above data is given based on "Technical Data Sheet" DB-Nr.32055-03 for reference only.

For details and the most update version, please contact our sales department for "The latest Technical Data Sheet".

以上数据来源于PMA工厂“技术数据表”DB-Nr.32055-03。因厂家会随时更新数据, 故相关数据仅供参考, 如要了解详细和最新技术资料请联系我司销售部索取《最新技术数据表》。

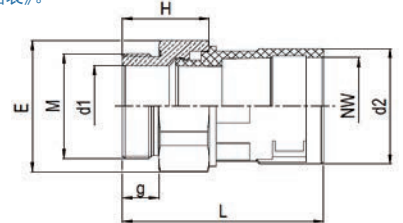

SBV-M

90° curved elbow, metric, metal thread, swivel 90° 曲线弯头, 公制, 金属螺纹, 旋转管接头

For applications with high technical requirements. 应用于高技术要求。

IP66/IP68

- Fitting body: high-grade, specially formulated polyamide 6
管接头: 高级, 特殊改良聚酰胺6制成
- Thread: nickel-plated brass
螺纹: 黄铜镀镍
- Very high impact resistance
非常高的抗冲击强度
- High conduit pull-out strength
高强度的抗拉能力
- High thread and system connection strength
高强度的螺纹和系统连接
- Vibration-proof connection to PMA conduits
配合PMA软管使用具有很好的防震作用
- Suitable for occasional rotation; Easy installation
适用于偶然的旋转; 易于安装
- Very good chemical properties
非常好的化学性能
- Free from halogens and cadmium; RoHS and REACH compliant
不含卤素和镉; RoHS 和 REACH 合规性
- Very good UV resistance and weathering characteristics
非常好的抗紫外线和耐候性能
- EN 45545-2 HL3 (R22 & R23)
HL3, 根据EN45545-2车内软管R22/车外软管R23标准
- NFPA 130
NFPA 130
- UL 94 (V0); UL 1696 (UL File E80294)
UL 94 (V0); UL 1696 (UL 文件 E80294)
- Fits both conduit profiles-fine (T) and coarse (G)
适用软管类型-细波纹 (T) 和粗波纹 (G)
- Temperature range: -50°C to +105°C; short-term: +160°C
温度范围: -50°C 至 +105°C; 短期温度: +160°C
- Content of delivery: fitting with oval clips (OVN2), conduit and thread gasket (NVN3, SVN4 and OR)
包装配件: 管接头和椭圆形夹子 (OVN2), 软管和螺纹密封圈 (NVN3, SVN4 和 OR)

Order No. black 订货号 黑色	Thread metric 螺纹 公制	Conduit size 软管规格 NW 标称内径 (mm)	Dimensions 尺寸				Packing unit 包装量 (pcs/PU)	MOQ 最小起订量 黑色N (pcs)
			g (mm)	d2 (mm)	A (mm)	B (mm)		
NSBV - M207 - 10	M20 x 1.5	17	10.0	29.5	62.5	74.5	1	-
**NSBV - M257 - 11	M25 x 1.5	17	11.0	29.5	63.0	75.7	1	10
NSBV - M253 - 11	M25 x 1.5	23	11.0	37.0	73.0	87.5	1	-
NSBV - M329 - 13	M32 x 1.5	29	13.0	44.0	86.5	98.0	1	-
# NSBV - M329 - 7	M32 x 1.5	29	7.0	44.0	80.5	98.0	1	10
NSBV - M406 - 13	M40 x 1.5	36	13.0	53.5	98.5	127.5	1	-
# NSBV - M406 - 7	M40 x 1.5	36	7.0	53.5	92.5	127.5	1	10
# NSBV - M409 - 13	M40 x 1.5	29	13.0	44.0	86.5	98.0	1	10
NSBV - M508 - 14	M50 x 1.5	48	14.0	66.0	113.5	139.0	1	-
NSBV - M638 - 14	M63 x 1.5	48	14.0	66.0	110.0	139.0	1	-

*Not approved to UL recognized to UL 1696 (UL file E 80294)

未获得UL中的UL1696(UL文件E80294)认可

The above data is given based on "Technical Data Sheet" DB-Nr.32045-07 for reference only.

For details and the most update version, please contact our sales department for "The latest Technical Data Sheet".

以上数据来源于PMA工厂“技术数据表”DB-Nr.32045-07。因厂家会随时更新数据, 故相关数据仅供参考, 如要了解详细和最新技术资料请联系我司销售部索取《最新技术数据表》。

标记为 # 的产品有最小起订量 (MOQ)

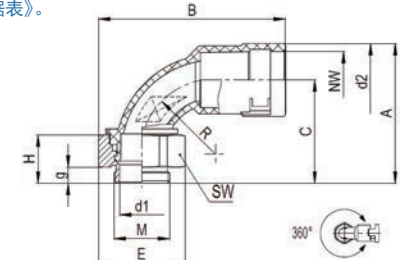

SWV-M

90° elbow, metric, metal thread, swivel 90°, 公制, 金属螺纹, 旋转管接头

For applications with high technical requirements. 应用于高技术要求。



IP66/IP68



Order No. black 订货号 黑色	Thread metric 螺纹 公制	Conduit size 软管规格 NW 标称内径 (mm)	Dimensions 尺寸				Packing unit 包装量 (pcs/PU)	MOQ 最小起订量 (pcs)
			g (mm)	d2 (mm)	A (mm)	B (mm)		
# NSWV-M120-10	M12 x 1.5	10	10.0	20.0	48.0	40.5	50	10
# NSWV-M162-10	M16 x 1.5	12	10.0	23.5	52.5	47.5	50	10

标记为 # 的产品有最小起订量 (MOQ)

- Fitting body: high-grade, specially formulated polyamide 6
管接头: 高级, 特殊改良聚酰胺6制成
- Thread: nickel-plated brass
螺纹: 黄铜镀镍
- Very high impact resistance: High conduit pull-out strength
非常高的抗冲击强度: 高强度的抗拉能力
- High thread and system connection strength
高强度的螺纹和系统连接
- Vibration-proof connection to PMA conduits
配合PMA软管使用具有很好的防震作用
- Suitable for occasional rotation; Easy installation
适用于偶然的旋转; 易于安装
- Very good chemical properties
非常好的化学性能
- Free from halogens and cadmium; RoHS and REACH compliant
不含卤素和镉; RoHS 和 REACH 合规性
- Very good UV resistance and weathering characteristics
非常好的抗紫外线和耐候性能
- EN 45545-2 HL3 (R22 & R23)
HL3, 根据EN45545-2车内软管R22/车外软管R23标准
- NFPA 130
NFPA 130
- UL 94 (V0); UL 1696 (UL File E80294)
UL 94 (V0); UL 1696 (UL 文件 E80294)
- Fits both conduit profiles-fine (T) and coarse (G)
适用软管类型-细波纹 (T) 和粗波纹 (G)
- Temperature range: -50°C to +105°C; short-term: +160°C
温度范围: -50°C 至 +105°C; 短期温度: +160°C
- Content of delivery: fitting with oval clips (OVN2), conduit and thread seals (NVN3, SVN4 and OR)
包装配件: 管接头和椭圆型夹子 (OVN2), 软管和螺纹密封圈 (NVN3, SVN4 和 OR)

The above data is given based on "Technical Data Sheet" DB-Nr.32016-04 for reference only.
For details and the most update version, please contact our sales department for "The latest Technical Data Sheet".
以上数据来源于PMA工厂“技术数据表”DB-Nr.32016-04。因厂家会随时更新数据, 故相关数据仅供参考, 如要了解详细和最新技术资料请联系我司销售部索取《最新技术数据表》。

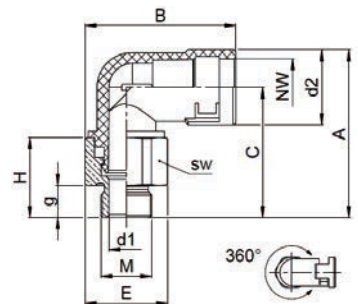

SBV-P

90° curved elbow, PG, metal thread, swivel 90° 曲线弯头, PG制, 金属螺纹, 旋转管接头

For applications with high technical requirements. 应用于高技术要求。



IP66/IP68



Order No. black 订货号 黑色	Thread PG 螺纹 PG	Conduit size 软管规格 NW 标称内径 (mm)	Dimensions 尺寸				Packing unit 包装量 (pcs/PU)	MOQ 最小起订量 (pcs)
			g (mm)	d2 (mm)	A (mm)	B (mm)		
NSBV-P167-6.5	16	17	6.5	29.5	58.0	74.5	1	-
NSBV-P213-7	21	23	7.0	37.0	69.0	87.5	1	-
NSBV-P299-8	29	29	8.0	44.0	80.0	98.0	1	-
NSBV-P366-9	36	36	9.0	53.5	91.5	127.5	1	-
# NSBV-P488-10	48	48	10.0	66.0	106.0	139.0	1	10

标记为 # 的产品有最小起订量 (MOQ)

- Fitting body: high-grade, specially formulated polyamide 6
管接头: 高级, 特殊改良聚酰胺6制成
- Thread: nickel-plated brass
螺纹: 黄铜镀镍
- Very high impact resistance
非常高的抗冲击强度
- High conduit pull-out strength
高强度的抗拉能力
- High thread and system connection strength
高强度的螺纹和系统连接
- Vibration-proof connection to PMA conduits
配合PMA软管使用具有很好的防震作用
- Suitable for occasional rotation; Easy installation
适用于偶然的旋转; 易于安装
- Very good chemical properties
非常好的化学性能
- Free from halogens and cadmium; RoHS and REACH compliant
不含卤素和镉; RoHS 和 REACH 合规性
- Very good UV resistance and weathering characteristics
非常好的抗紫外线和耐候性能
- EN 45545-2 HL3 (R22 & R23)
HL3, 根据EN45545-2车内软管R22/车外软管R23标准
- NFPA 130
NFPA 130
- UL 94 (V0); UL 1696 (UL File E80294)
UL 94 (V0); UL 1696 (UL 文件 E80294)
- Fits both conduit profiles-fine (T) and coarse (G)
适用软管类型-细波纹 (T) 和粗波纹 (G)
- Temperature range: -50°C to +105°C; short-term: +160°C
温度范围: -50°C 至 +105°C; 短期温度: +160°C
- Content of delivery: fitting with oval clips (OVN2), conduit and thread seals (NVN3, SVN4 and OR)
包装配件: 管接头和椭圆型夹子 (OVN2), 软管和螺纹密封圈 (NVN3, SVN4 和 OR)

The above data is given based on "Technical Data Sheet" DB-Nr.32040-08 for reference only.
For details and the most update version, please contact our sales department for "The latest Technical Data Sheet".
以上数据来源于PMA工厂“技术数据表”DB-Nr.32040-08。因厂家会随时更新数据, 故相关数据仅供参考, 如要了解详细和最新技术资料请联系我司销售部索取《最新技术数据表》。

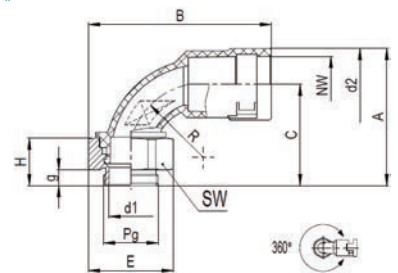

SNV-N *straight, NPT, metal thread, swivel* 直型, NPT制, 金属螺纹, 旋转管接头

For applications with high technical requirements. 应用于高技术要求。



IP66/IP68

Order No. black 订货号 黑色	Thread NPT 螺纹 NPT	Conduit size 软管规格 NW 标称内径 (mm)	Dimensions 尺寸			Packing unit 包装量 (pcs/PU)	MOQ 最小起订量 (pcs)
			g (mm)	L (mm)	d2 (mm)		
# NSNV-N022/01	1/2"	12	11.8	57.4	23.5	1	10
# NSNV-N027/01	1/2"	17	11.8	66.2	29.5	1	10
# NSNV-N043/01	3/4"	23	12.1	72.0	37.0	1	10
# NSNV-N069/01	1"	29	15.2	77.4	44.0	1	10
# NSNV-N076/01	1 1/4"	36	15.8	91.4	53.5	1	10
# NSNV-N088/01	1 1/2"	48	16.2	92.8	66.0	1	10
# NSNV-N098/01	2"	48	17.0	95.1	66.0	1	10

- Fitting body: high-grade, specially formulated polyamide 6
管接头: 高级, 特殊改良聚酰胺6制成
- Thread: colourless anodized aluminium
螺纹: 无色阳极氧化铝
- Very high impact resistance
非常高的抗冲击强度
- High conduit pull-out strength
高强度的抗拉能力
- High thread and system connection strength
高强度的螺纹和系统连接
- Vibration-proof connection to PMA conduits
配合PMA软管使用具有很好的防震作用
- Suitable for occasional rotation; Easy installation
适用于偶然的旋转; 易于安装
- Very good chemical properties
非常好的化学性能
- Free from halogens and cadmium; RoHS and REACH compliant
不含卤素和镉; RoHS 和 REACH 合规性
- Very good UV resistance and weathering characteristics
非常好的抗紫外线和耐候性能
- EN 45545-2 HL3 (R22 & R23)
HL3. 根据EN45545-2车内软管R22/车外软管R23标准
- NFPA 130
NFPA 130
- UL 94 (V0); UL 1696 (UL File E80294)
UL 94 (V0); UL 1696 (UL 文件 E80294)
- Fits both conduit profiles-fine (T) and coarse (G)
适用软管类型-细波纹 (T) 和粗波纹 (G)
- Temperature range: -50°C to +105°C; short-term: +160°C
温度范围: -50°C 至 +105°C; 短期温度: +160°C
- Content of delivery: fitting with oval clips (OVN2), conduit and thread seals (NVN3, SVN4)
包装配件: 管接头和椭圆形夹子 (OVN2), 软管和螺纹密封圈 (NVN3, SVN4)

标记为 # 的产品有最小起订量 (MOQ)

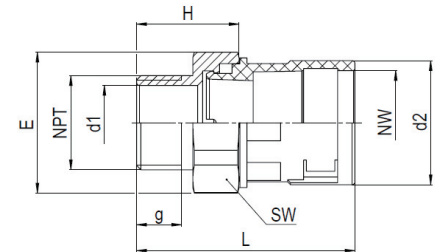
The above data is given based on "Technical Data Sheet" DB-Nr.32090-05 for reference only.
For details and the most update version, please contact our sales department for "The latest Technical Data Sheet."
以上数据来源于PMA工厂“技术数据表”DB-Nr.32090-05。因厂家会随时更新数据, 故相关数据仅供参考,
如要了解详细和最新技术资料请联系我司销售部索取《最新技术数据表》。

SNIV-N *straight, NPT female, metal thread, swivel* 直型, NPT制, 金属内螺纹, 旋转管接头

For applications with high technical requirements. 应用于高技术要求。



IP66/IP68

Order No. black 订货号 黑色	Thread NPT 螺纹 NPT	Conduit size 软管规格 NW 标称内径 (mm)	Dimensions 尺寸			Packing unit 包装量 (pcs/PU)	MOQ 最小起订量 (pcs)
			g (mm)	L (mm)	d2 (mm)		
# NSNIV-N022/01	1/2"	12	11.0	58.7	23.5	1	10
# NSNIV-N027/01	1/2"	17	13.6	67.0	29.5	1	10
# NSNIV-N043/01	3/4"	23	14.1	72.3	37.0	1	10
# NSNIV-N069/01	1"	29	16.8	76.5	44.0	1	10
# NSNIV-N076/01	1 1/4"	36	17.3	89.9	53.5	1	10
# NSNIV-N088/01	1 1/2"	48	17.3	90.4	66.0	1	10
# NSNIV-N098/01	2"	48	17.7	92.3	66.0	1	10

- Fitting body: high-grade, specially formulated polyamide 6
管接头: 高级, 特殊改良聚酰胺6制成
- Thread: colourless anodized aluminium
螺纹: 无色阳极氧化铝
- Very high impact resistance
非常高的抗冲击强度
- High thread and system connection strength
高强度的螺纹和系统连接
- Vibration-proof connection to PMA conduits
配合PMA软管使用具有很好的防震作用
- Suitable for occasional rotation; Easy installation
适用于偶然的旋转; 易于安装
- High conduit pull-out strength
高强度的抗拉能力
- Very good chemical properties
非常好的化学性能
- Free from halogens and cadmium; RoHS and REACH compliant
不含卤素和镉; RoHS 和 REACH 合规性
- Very good UV resistance and weathering characteristics
非常好的抗紫外线和耐候性能
- EN 45545-2 HL3 (R22 & R23)
HL3. 根据EN45545-2车内软管R22/车外软管R23标准
- NFPA 130
NFPA 130
- UL 94 (V0); UL 1696 (UL File E80294)
UL 94 (V0); UL 1696 (UL 文件 E80294)
- Fits both conduit profiles-fine (T) and coarse (G)
适用软管类型-细波纹 (T) 和粗波纹 (G)
- Temperature range: -50°C to +105°C; short-term: +160°C
温度范围: -50°C 至 +105°C; 短期温度: +160°C
- Content of delivery: fitting with oval clips (OVN2), conduit gasket (NVN3)
包装配件: 管接头和椭圆形夹子 (OVN2), 软管密封圈 (NVN3)

标记为 # 的产品有最小起订量 (MOQ)

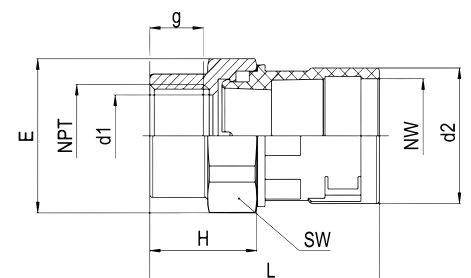
The above data is given based on "Technical Data Sheet" DB-Nr.32092-05 for reference only.
For details and the most update version, please contact our sales department for "The latest Technical Data Sheet."
以上数据来源于PMA工厂“技术数据表”DB-Nr.32092-05。因厂家会随时更新数据, 故相关数据仅供参考,
如要了解详细和最新技术资料请联系我司销售部索取《最新技术数据表》。



SBV-N

90° curved elbow, NPT, metal thread, swivel

90° 曲线弯头, NPT制, 金属螺纹, 旋转管接头

For applications with high technical requirements.

应用于高技术要求。



IP66/IP68



- Fitting body: high-grade, specially formulated polyamide 6
管接头: 高级, 特殊改良聚酰胺6制成
- Thread: colourless anodized aluminium
螺纹: 无色阳极氧化铝
- Very high impact resistance
非常高的抗冲击强度
- High conduit pull-out strength
高强度的抗拉能力
- High thread and system connection strength
高强度的螺纹和系统连接
- Vibration-proof connection to PMA conduits
配合PMA软管使用具有很好的防震作用
- Suitable for occasional rotation; Easy installation
适用于偶然的旋转; 易于安装
- Very good chemical properties
非常好的化学性能
- Free from halogens and cadmium; RoHS and REACH compliant
不含卤素和镉; RoHS 和 REACH 合规性
- Very good UV resistance and weathering characteristics
非常好的抗紫外线和耐候性能
- EN 45545-2 HL3 (R22 & R23)
HL3. 根据EN45545-2车内软管R22/车外软管R23标准
- NFPA 130
- UL 94 (V0); UL 1696 (UL File E80294)
UL 94 (V0); UL 1696 (UL 文件 E80294)
- Fits both conduit profiles-fine (T) and coarse (G)
适用软管类型-细波纹 (T) 和粗波纹 (G)
- Temperature range: -50°C to +105°C; short-term: +160°C
温度范围: -50°C 至 +105°C; 短期温度: +160°C
- Content of delivery: fitting with oval clips (OVN2), conduit and thread seals (NVN3, SVN4)
包装配件: 管接头和椭圆形夹子 (OVN2), 软管和螺纹密封圈 (NVN3, SVN4)

Order No. black 订货号 黑色	Thread NPT 螺纹 NPT	Conduit size 软管规格 NW 标称内径 (mm)	Dimensions 尺寸				Packing unit 包装量 (pcs/PU)	MOQ 最小起订量 (pcs)
			g (mm)	d2 (mm)	A (mm)	B (mm)		
# * NSWV-N022/01	1/2"	12	11.8	23.5	56.7	48.5	1	10
# NSBV-N027/01	1/2"	17	11.8	29.5	66.2	74.2	1	10
# NSBV-N043/01	3/4"	23	12.1	37.0	77.5	87.5	1	10
# NSBV-N069/01	1"	29	15.2	44.0	91.9	98.0	1	10
# NSBV-N076/01	1 1/4"	36	15.8	53.5	104.5	125.2	1	10
# NSBV-N088/01	1 1/2"	48	16.2	66.0	118.9	138.2	1	10
# NSBV-N098/01	2"	48	17.0	66.0	121.2	138.2	1	10

* =90° elbow of connector 此接头是90°直角弯头

标记为 # 的产品有最小起订量 (MOQ)

The above data is given based on "Technical Data Sheet" DB-Nr.32094-06 for reference only.

For details and the most update version, please contact our sales department for "The latest Technical Data Sheet".

以上数据来源于PMA工厂“技术数据表”DB-Nr.32094-06。因厂家会随时更新数据,故相关数据仅供参考,如要了解详细和最新技术资料请联系我司销售部索取《最新技术数据表》。

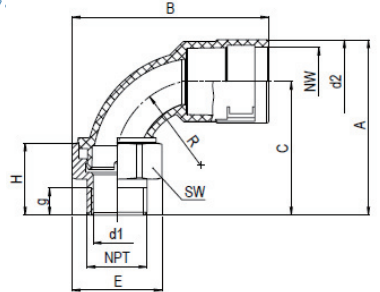

SBIV-N

90° curved elbow, NPT, female metal thread, 360° swivel

90° 曲线弯头, NPT制, 金属内螺纹, 360° 旋转管接头

For applications with high technical requirements.

应用于高技术要求。



IP66/IP68



- Fitting body: high-grade, specially formulated polyamide 6
管接头: 高级, 特殊改良聚酰胺6制成
- Thread: colourless anodized aluminium
螺纹: 无色阳极氧化铝
- Very high impact resistance
非常高的抗冲击强度
- High thread and system connection strength
高强度的螺纹和系统连接
- Vibration-proof connection to PMA conduits
配合PMA软管使用具有很好的防震作用
- Suitable for occasional rotation; Easy installation
适用于偶然的旋转; 易于安装
- High conduit pull-out strength; Very good chemical properties
高强度的抗拉能力; 非常好的化学性能
- Free from halogens and cadmium; RoHS and REACH compliant
不含卤素和镉; RoHS 和 REACH 合规性
- Very good UV resistance and weathering characteristics
非常好的抗紫外线和耐候性能
- EN 45545-2 HL3 (R22 & R23)
HL3. 根据EN45545-2车内软管R22/车外软管R23标准
- NFPA 130
- UL 94 (V0); UL 1696 (UL File E80294)
UL 94 (V0); UL 1696 (UL 文件 E80294)
- Fits both conduit profiles-fine (T) and coarse (G)
适用软管类型-细波纹 (T) 和粗波纹 (G)
- Temperature range: -50°C to +105°C; short-term: +160°C
温度范围: -50°C 至 +105°C; 短期温度: +160°C
- Content of delivery: fitting with oval clips (OVN2), conduit gasket (NVN3)
包装配件: 管接头和椭圆形夹子 (OVN2), 软管密封圈 (NVN3)

Order No. black 订货号 黑色	Thread NPT 螺纹 NPT	Conduit size 软管规格 NW 标称内径 (mm)	Dimensions 尺寸				Packing unit 包装量 (pcs/PU)	MOQ 最小起订量 (pcs)
			g (mm)	d2 (mm)	A (mm)	B (mm)		
# * NSWIV-N022 / 01	1/2"	12	11.0	23.5	58.0	48.5	1	10
# NSBIV-N027 / 01	1/2"	17	13.6	29.5	67.0	74.2	1	10
# NSBIV-N043 / 01	3/4"	23	14.1	37.0	77.8	87.5	1	10
# NSBIV-N069 / 01	1"	29	16.8	44.0	91.0	98.0	1	10
# NSBIV-N076 / 01	1 1/4"	36	17.3	53.5	103.0	125.2	1	10
# NSBIV-N088 / 01	1 1/2"	48	17.3	66.0	116.5	138.2	1	10
# NSBIV-N098 / 01	2"	48	17.7	66.0	118.4	138.2	1	10

* =90° elbow of connector 此接头是90°直角弯头

标记为 # 的产品有最小起订量 (MOQ)

The above data is given based on "Technical Data Sheet" DB-Nr.32096-05 for reference only.

For details and the most update version, please contact our sales department for "The latest Technical Data Sheet".

以上数据来源于PMA工厂“技术数据表”DB-Nr.32096-05。因厂家会随时更新数据,故相关数据仅供参考,如要了解详细和最新技术资料请联系我司销售部索取《最新技术数据表》。

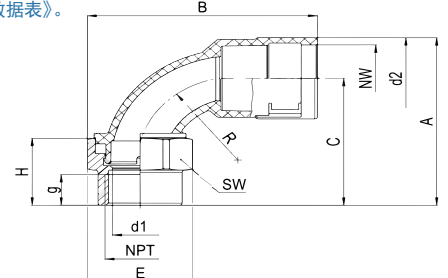

SHV-U

90° curved elbow, female metal UNEF thread, swivel

90° 曲线弯头, 金属UNEF内螺纹, 旋转管接头

For applications with high technical requirements.

应用于高技术要求。



IP66/IP68



- Fitting body: high-grade, specially formulated polyamide 6
管接头: 高级, 特殊改良聚酰胺6制成
- Thread: black anodized aluminium
螺纹: 黑色阳极氧化铝
- Very high impact resistance
非常高的抗冲击强度
- High conduit pull-out strength
高强度的抗拉能力
- High thread and system connection strength
高强度的螺纹和系统连接
- Vibration-proof connection to PMA conduits
配合PMA软管使用具有很好的防震作用
- Suitable for occasional rotation; Easy installation
适用于偶然的旋转; 易于安装
- Very good chemical properties
非常好的化学性能
- Free from halogens and cadmium; RoHS and REACH compliant
不含卤素和镉; RoHS 和 REACH 合规性
- Very good UV resistance and weathering characteristics
非常好的抗紫外线和耐候性能
- EN 45545-2 HL3 (R22 & R23)
HL3, 根据EN45545-2车内软管R22/车外软管R23标准
- NFPA 130
NFPA 130
- UL 94 (V0); UL 1696 (UL File E80294)
UL 94 (V0); UL 1696 (UL 文件 E80294)
- Fits both conduit profiles-fine (T) and coarse (G)
适用软管类型-细波纹 (T) 和粗波纹 (G)
- Temperature range: -50°C to +105°C; short-term: +160°C
温度范围: -50°C 至 +105°C; 短期温度: +160°C
- Content of delivery: fitting with oval clips (OVN2), conduit and thread seals (NVN3 and OR)
包装配件: 管接头和椭圆型夹子 (OVN2), 软管和螺纹密封圈 (NVN3 和 OR)

Order No. black 订货号 黑色	Thread UNEF 螺纹 UNEF	Conduit size 软管规格 NW 标称内径 (mm)	Dimensions 尺寸				Packing unit 包装量 (pcs/PU)	MOQ 最小起订量 黑色 (pcs)
			g (mm)	d2 (mm)	A (mm)	B (mm)		
# NSHV-U357/01	1 7/16"-18	17	11.0	29.5	71.5	79.5	1	10
# NSHV-U353/01	1 7/16"-18	23	11.0	37.0	80.5	89.0	1	10
# NSHV-U503/01	2"-18 UNS	23	11.0	37.0	82.0	95.0	1	10
# NSHV-U509/01	2"-18 UNS	29	11.0	44.0	91.0	102.0	1	10
# NSHV-U506/01	2"-18 UNS	36	11.0	53.5	102.5	123.0	1	-

标记为 # 的产品有最小起订量 (MOQ)

The above data is given based on "Technical Data Sheet" DB-Nr.32061-02 for reference only.

For details and the most update version, please contact our sales department for "The latest Technical Data Sheet".

以上数据来源于PMA工厂“技术数据表”DB-Nr.32061-02。因厂家会随时更新数据, 故相关数据仅供参考, 如要了解详细和最新技术资料请联系我司销售部索取《最新技术数据表》。

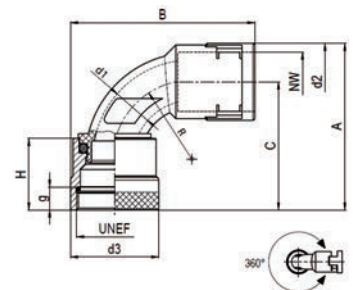

SCA-M

positioning adapter, metric metal thread 定位适配器, 公制金属螺纹

In connection with PMA fittings with metal thread. 与带金属螺纹的PMA管接头连接。



IP66/IP68/IP69



- Nickel-plated brass
(other materials e.g. stainless steel available on request)
黄铜镀镍制成 (可根据要求提供其他材料, 如不锈钢)
- Allows easy positioning of elbow fittings with metal thread
与带有金属螺纹的弯型管接头配合使用, 容易固定接头位置
- High fastening torque
高紧固扭矩
- With thread edge protection
带螺纹边缘保护
- Free from halogens and cadmium
不含卤素和镉
- RoHS and REACH compliant
RoHS 和 REACH 合规性
- Temperature range: -50°C to +105°C
温度范围: -50°C 至 +105°C
- Content of delivery: adapter, thread seal (SVN4 and OR)
包装配件: 旋转耦合器, 螺纹密封圈 (SVN4 和 OR)

Order No. black 订货号 黑色	Thread metric 螺纹 公制	Conduit size 软管规格 NW 标称内径 (mm)	Dimensions 尺寸			Packing unit 包装量 (pcs/PU)	MOQ 最小起订量 (pcs)
			g (mm)	A (mm)	d2 (mm)		
SCA-M16-10	M16 x 1.5	22.0	10	32.0	22.0	1	-
SCA-M20-10	M20 x 1.5	26.0	10	33.0	26.0	1	-
SCA-M25-11	M25 x 1.5	32.0	11	35.0	32.0	1	-
SCA-M32-13	M32 x 1.5	39.0	13	39.5	39.0	1	-
SCA-M40-13	M40 x 1.5	50.0	13	41.0	50.0	1	-
SCA-M50-14	M50 x 1.5	59.0	14	43.5	59.0	1	-
# SCA-M63-14	M63 x 1.5	75.0	14	45.5	75.0	1	10

标记为 # 的产品有最小起订量 (MOQ)

The above data is given based on "Technical Data Sheet" DB-Nr.51065-08 for reference only.

For details and the most update version, please contact our sales department for "The latest Technical Data Sheet".

以上数据来源于PMA工厂“技术数据表”DB-Nr.51065-08。因厂家会随时更新数据, 故相关数据仅供参考, 如要了解详细和最新技术资料请联系我司销售部索取《最新技术数据表》。

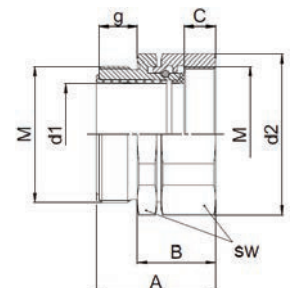

SCA-P

positioning adapter, PG thread 定位适配器, PG螺纹

In connection with PMA fittings with metal thread. 与带金属螺纹的PMA管接头连接。



IP66/IP68/IP69



- Nickel-plated brass (other materials e.g. stainless steel available on request)
黄铜镀镍制成 (可根据要求提供其他材料, 如不锈钢)
- Allows the easy positioning of elbow fittings with metal thread
与带有金属螺纹的弯型管接头配合使用, 容易固定接头位置
- High fastening torque
高紧固扭矩
- With thread edge protection
带螺纹边缘保护
- Free from halogens and cadmium
不含卤素和镉
- RoHS and REACH compliant
RoHS 和 REACH 合规性
- Temperature range: -50°C to +105°C
温度范围: -50°C 至 +105°C
- Content of delivery: adapter, thread seal (SVN4 and OR)
包装配件: 旋转耦合器, 螺纹密封圈 (SVN4 和 OR)

Order No. 订货号	Thread PG 螺纹 PG	Dimensions 尺寸			Packing unit 包装量 (pcs/PU)	MOQ 最小起订量 (pcs)
		g (mm)	A (mm)	d2 (mm)		
# SCA - P09	09	12	35.0	22.0	1	10
# SCA - P11	11	12	36.0	26.0	1	10
# SCA - P16	16	13	38.0	29.0	1	10
# SCA - P21	21	14	41.0	39.0	1	10
# SCA - P29	29	14	42.5	44.0	1	10
# SCA - P36	36	17	49.0	59.0	1	10
# SCA - P48	48	17	50.5	69.0	1	10

标记为 # 的产品有最小起订量 (MOQ)

The above data is given based on "Technical Data Sheet" DB-Nr.51060-14 for reference only.
For details and the most update version, please contact our sales department for "The latest Technical Data Sheet".
以上数据来源于PMA工厂“技术数据表”DB-Nr.51060-14。因厂家会随时更新数据, 故相关数据仅供参考, 如要了解详细和最新技术资料请联系我司销售部索取《最新技术数据表》。

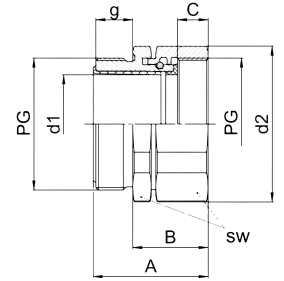

SCAK-M

special positioning adapter, metric metal thread 特殊定位适配器, 公制金属螺纹

In connection with PMA fittings with metal thread. 与带金属螺纹的PMA管接头连接。



IP66/IP68/IP69



- Nickel-plated brass (other materials e.g. stainless steel available on request)
黄铜镀镍制成 (可根据要求提供其他材料, 如不锈钢)
- Allows easy positioning of elbow connectors with exactly fixation of the outlet direction in a given thread hole
可以轻松定位弯头管接头, 并精确固定出线方向
- High fastening torque
高紧固扭矩
- With thread edge protection
带螺纹边缘保护
- Free from halogens and cadmium
不含卤素和镉
- RoHS and REACH compliant
RoHS 和 REACH 合规性
- Temperature range: -60°C to +105°C
温度范围: -60°C 至 +105°C
- Content of delivery: adapter, thread seal (SVN4 and OR)
包装配件: 旋转耦合器, 螺纹密封圈 (SVN4 和 OR)

Order No. 订货号	Thread inside metric 内螺纹 公制	Thread outside metric 外螺纹 公制	Dimensions 尺寸			Packing unit 包装量 (pcs/PU)	MOQ 最小起订量 (pcs)
			g (mm)	A (mm)	d2 (mm)		
# SCAK - M20 - 10	M20 X 1.5	M20 X 1.5	10	31.5	26.0	1	10
# SCAK - M25 - 11	M25 X 1.5	M25 X 1.5	11	35.0	32.0	1	10
# SCAK - M32 - 13	M32 X 1.5	M32 X 1.5	13	38.0	39.0	1	10
# SCAK - M40 - 13	M40 X 1.5	M40 X 1.5	13	39.0	50.0	1	10
# SCAK - M50 - 14	M50 X 1.5	M50 X 1.5	14	41.5	59.0	1	TBA待定
# SCAK - M63 - 14	M63 X 1.5	M63 X 1.5	14	43.0	75.0	1	TBA待定

标记为 # 的产品有最小起订量 (MOQ)
待定 = MOQ需与工厂确认

The above data is given based on "Technical Data Sheet" DB-Nr.51068-05 for reference only.
For details and the most update version, please contact our sales department for "The latest Technical Data Sheet".
以上数据来源于PMA工厂“技术数据表”DB-Nr.51068-05。因厂家会随时更新数据, 故相关数据仅供参考, 如要了解详细和最新技术资料请联系我司销售部索取《最新技术数据表》。

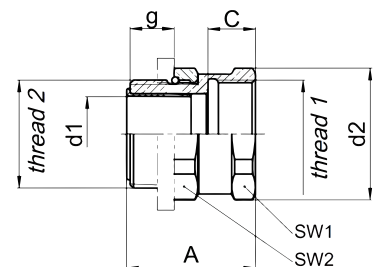

SWA-M

swivel adapter, metric metal thread 旋转适配器, 公制金属螺纹

In connection with PMA fittings with metal thread. 与带金属螺纹的PMA管接头连接。

CE

IP66/IP68/IP69



- Nickel-plated brass (other materials e.g. stainless steel available on request)
黄铜镀镍制成 (可根据要求提供其他材料, 如不锈钢)
- Allows PMA fittings to swivel freely in applications where such movement is occasionally necessary
某些需要偶尔运动的场合, 允许PMA管接头自由旋转
- With thread edge protection
带螺纹边缘保护
- Free from halogens and cadmium
不含卤素和镉
- RoHS and REACH compliant
RoHS 和 REACH 合规性
- Temperature range: -50°C to +105°C
温度范围: -50°C 至 +105°C
- Content of delivery: adapter, thread seal (SVN4 and OR)
包装配件: 适配器, 螺纹密封圈 (SVN4 和 OR)

Order No. 订货号	Thread inside metric 内螺纹 公制	Thread outside metric 外螺纹 公制	Dimensions 尺寸			Packing unit 包装量 (pcs/PU)
			g (mm)	A (mm)	d2 (mm)	
SWA - M16 - 10	M16 x 1.5	M16 x 1.5	10	37.5	23.0	1
SWA - M20 - 10	M20 x 1.5	M20 x 1.5	10	38.5	27.0	1
SWA - M25 - 11	M25 x 1.5	M25 x 1.5	11	41.0	32.0	1
SWA - M32 - 13	M32 x 1.5	M32 x 1.5	13	46.5	45.0	1
SWA - M40 - 13	M40 x 1.5	M40 x 1.5	13	47.5	55.0	1
SWA - M50 - 14	M50 x 1.5	M50 x 1.5	14	49.5	59.0	1
SWA - M63 - 14	M63 x 1.5	M63 x 1.5	14	52.0	75.0	1

The above data is given based on "Technical Data Sheet" DB-Nr.51075-10 for reference only.

For details and the most update version, please contact our sales department for "The latest Technical Data Sheet".

以上数据来源于PMA工厂“技术数据表”DB-Nr.51075-10。因厂家会随时更新数据, 故相关数据仅供参考, 如要了解详细和最新技术资料请联系我司销售部索取《最新技术数据表》。

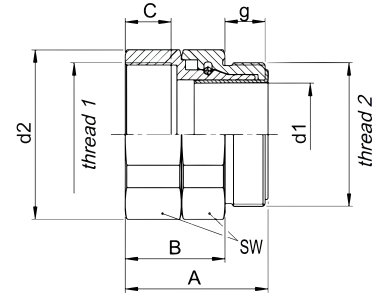

SWA-P

swivel adapter, PG metal thread 旋转适配器, PG 金属螺纹

In connection with PMA fittings with metal thread. 与带金属螺纹的PMA管接头连接。

CE

IP66/IP68/IP69



- Nickel-plated brass (other materials e.g. stainless steel available on request)
黄铜镀镍制成 (可根据要求提供其他材料, 如不锈钢)
- Allows PMA fittings to swivel freely in applications where such movement is occasionally necessary
某些需要偶尔运动的场合, 允许PMA管接头自由旋转
- With thread edge protection
带螺纹边缘保护
- Free from halogens and cadmium
不含卤素和镉
- RoHS and REACH compliant
RoHS 和 REACH 合规性
- Temperature range: -50°C to +105°C
温度范围: -50°C 至 +105°C
- Content of delivery: adapter, thread seal (SVN4 and OR)
包装配件: 适配器, 螺纹密封圈 (SVN4 和 OR)

Order No. black 订货号	Thread inside PG 内螺纹 PG	Thread outside PG 外螺纹 PG	Dimensions 尺寸			Packing unit 包装量 (pcs/PU)	MOQ 最小起订量 (pcs)
			g (mm)	A (mm)	d2 (mm)		
# SWA - P09	09	09	15	44.5	23.0	1	10
# SWA - P11	11	11	15	45.5	27.0	1	10
# SWA - P16	16	16	15	48.0	32.0	1	10
# SWA - P21	21	21	15	51.0	40.0	1	10
SWA - P29	29	29	15	52.0	50.0	1	-
SWA - P36	36	36	15	55.0	59.0	1	-
SWA - P48	48	48	15	55.0	70.0	1	-
# SWA - M56P48	48	M56 X 2.0	18	56.0	70.0	1	TBA特定

标记为 # 的产品有最小起订量 (MOQ)
特定 = MOQ需与工厂确认

The above data is given based on "Technical Data Sheet" DB-Nr.51070-16 for reference only.

For details and the most update version, please contact our sales department for "The latest Technical Data Sheet".

以上数据来源于PMA工厂“技术数据表”DB-Nr.51070-16。因厂家会随时更新数据, 故相关数据仅供参考, 如要了解详细和最新技术资料请联系我司销售部索取《最新技术数据表》。

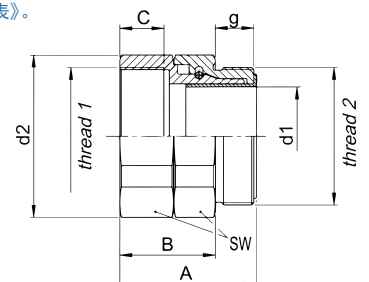

SWAI-M

swivel adapter with special sealing, metric metal thread, female

旋转适配器, 具有特别密封性能, 公制金属内螺纹

In connection with PMA fittings with metal thread.

与带金属螺纹的PMA管接头连接。



IP66/IP68/IP69



- Nickel-plated brass (other materials e.g. stainless steel available on request)
黄铜镀镍制成 (可根据要求提供其他材料, 如不锈钢)
- Allows PMA fittings to swivel freely in applications where such movement is occasionally necessary
某些需要偶尔运动的场合, 允许PMA管接头自由旋转
- Free from halogens and cadmium
不含卤素和镉
- RoHS and REACH compliant
RoHS 和 REACH 合规性
- Temperature range: -50°C to +105°C
温度范围: -50°C 至 +105°C
- Content of delivery: complete adapter with special sealing
包装配件: 完整适配器, 带有特殊的密封

Order No. 订货号	Thread inside metric female 公制 内螺纹 thread 1	Thread inside metric female 公制 内螺纹 thread 2	Dimensions 尺寸			Packing unit 包装量 (pcs/PU)	MOQ 最小起订量 (pcs)
			g (mm)	A (mm)	d2 (mm)		
# SWAI-M25-11	M25x1.5	M25x1.5	11.0	42.0	32.0	1	10
# SWAI-M32-13	M32x1.5	M32x1.5	13.0	46.0	45.0	1	10
# SWAI-M40-13	M40x1.5	M40x1.5	13.0	49.0	55.0	1	10

标记为 # 的产品有最小起订量 (MOQ)

The above data is given based on "Technical Data Sheet" DB-Nr.51077-05 for reference only.

For details and the most update version, please contact our sales department for "The latest Technical Data Sheet".

以上数据来源于PMA工厂“技术数据表”DB-Nr.51077-05。因厂家会随时更新数据, 故相关数据仅供参考, 如要了解详细和最新技术资料请联系我司销售部索取《最新技术数据表》。

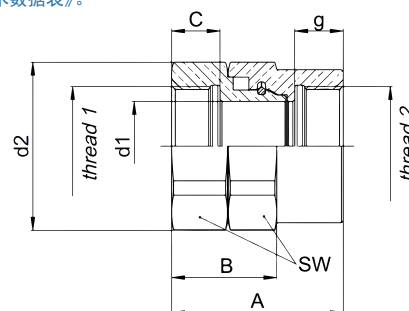

special elbow adapter, metric thread

特别弯曲适配器, 公制螺纹

In connection with PMA connectors, especially connectors with strain relief VNZ. For high loads. Where certain cable outlet angles are required.

与PMA管接头配合使用, 特别是VNZ系列消除应力管接头。适用于高负载场合。应用于电缆出口角度有一定要求的场合。



MAVI-M

IP66/IP68/IP69



- Nickel-plated aluminium (other materials e.g. stainless steel or nickel plated brass available on request)
铝镀镍制成 (可根据要求提供其他材料, 如不锈钢或黄铜镀镍)
- Very high impact resistance
非常高的抗冲击强度
- High thread and system connection strengths
高强度的螺纹和系统连接
- Enables different mounting positions:
适合多种安装位置
- with a lock nut behind a clearance hole
光孔后端用锁紧螺母锁紧
- Available outlet directions:
提供各种出口角度
- 45° (MAVI-Mxx/01)
- 30° (MAVI-Mxx/02) on request
按需要提供
- 15° (MAVI-Mxx/03) on request
按需要提供
- IP68 stat. / IP67 dyn.
IP68静态 / IP67动态
- Free from halogens and cadmium
不含卤素和镉
- RoHS and REACH compliant
RoHS 和 REACH 合规性
- Temperature range: -60°C to +105°C
温度范围: -60°C 至 +105°C
- Content of delivery: adapter, thread seal (SVN4 and OR)
包装配件: 适配器, 螺纹密封圈 (SVN4 和 OR)

Order No. 订货号	Thread inside metric 公制 内螺纹 thread 1	Thread outside metric 公制 外螺纹 thread 2	Dimensions 尺寸					Packing unit 包装量 (pcs/PU)	MOQ 最小起订量		
			g (mm)	d2 (mm)	01/45° L (mm)	02/30° L (mm)	03/15° L (mm)		01/45° (pcs)	02/30° (pcs)	03/15° (pcs)
# MAVI-M20/xx	M20x1.5	M20x1.5	10.0	35.0	45.0	42.0	38.0	10	-	10	10
# MAVI-M25/xx	M25x1.5	M25x1.5	11.0	39.0	51.0	47.0	42.5	10	-	10	10
# MAVI-M32/xx	M32x1.5	M32x1.5	13.0	46.0	54.0	50.0	44.0	10	10	10	10
# MAVI-M40/xx	M40x1.5	M40x1.5	13.0	55.0	62.0	57.5	48.5	10	-	10	10
# MAVI-M50/xx	M50x1.5	M50x1.5	14.0	65.0	75.0	68.0	58.0	10	10	10	10
# MAVI-M63/xx	M63x1.5	M63x1.5	14.0	80.0	84.0	76.5	60.5	10	10	10	10

标记为 # 的产品有最小起订量 (MOQ)

The above data is given based on "Technical Data Sheet" DB-Nr.51085-09 for reference only.

For details and the most update version, please contact our sales department for "The latest Technical Data Sheet".

以上数据来源于PMA工厂“技术数据表”DB-Nr.51085-09。因厂家会随时更新数据, 故相关数据仅供参考, 如要了解详细和最新技术资料请联系我司销售部索取《最新技术数据表》。

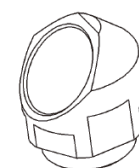
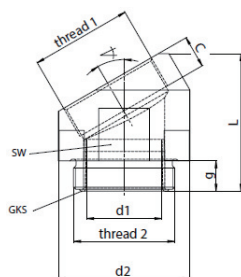
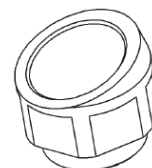
Outlet directions:
45° elbow / MAVI-Mxx/01Outlet directions:
30° elbow / MAVI-Mxx/02
(on request)Outlet directions:
15° elbow / MAVI-Mxx/03
(on request)

MAVI-P

special elbow adapter, PG thread 特别弯曲适配器, PG螺纹

In connection with PMA connectors, especially connectors with strain relief VNZ. For high loads. Where certain cable outlet angles are required. 与PMA管接头配合使用, 特别是VNZ系列消除应力管接头。适用于高负载场合。应用于电缆出口角度有一定要求的场合。



IP66/IP68



Order No. 订货号	Thread inside PG 内螺纹 thread 1	Thread outside PG 外螺纹 thread 2	Dimensions 尺寸					Packing unit 包装量 (pcs/PU)	MOQ 最小起订量		
			g (mm)	d2 (mm)	01/45° L (mm)	02/30° L (mm)	03/15° L (mm)		01/45° (pcs)	02/30° (pcs)	03/15° (pcs)
# MAVI-P16 / xx	PG16	PG16	13.0	39.0	48.0	47.0	42.0	10	10	10	10
# MAVI-P21 / xx	PG21	PG21	14.0	45.0	54.5	51.5	45.5	10	10	10	10
# MAVI-P29 / xx	PG29	PG29	14.0	55.0	61.0	59.0	52.0	10	10	10	10
# MAVI-P36 / xx	PG36	PG36	17.0	65.0	76.0	71.5	67.5	10	10	10	10
# MAVI-P48 / xx	PG48	PG48	17.0	75.0	82.0	79.5	74.5	10	10	10	10

标记为 # 的产品有最小起订量 (MOQ)

- Nickel-plated aluminium (other materials e.g. stainless steel or nickel plated brass available on request)
铝镀镍制成 (可根据要求提供其他材料, 如不锈钢或黄铜镀镍)
- Very high impact resistance
非常高的抗冲击强度
- High thread and system connection strengths
高强度的螺纹和系统连接
- Enables different mounting positions:
适合多种安装位置
- with a lock nut behind a clearance hole
光孔后端用锁紧螺母锁紧
- Available outlet directions:
提供各种出口角度
- 45° (MAVI-Pxx / 01)
- 30° (MAVI-Pxx / 02) on request
按需要提供
- 15° (MAVI-Pxx / 03) on request
按需要提供
- IP68 stat. / IP67 dyn.
IP68静态 / IP67动态
- Free from halogens and cadmium
不含卤素和镉
- RoHS and REACH compliant
RoHS 和 REACH 合规性
- Temperature range: -60°C to +105°C
温度范围: -60°C 至 +105°C
- Content of delivery: adapter, thread seal (SVN4 and OR)
包装配件: 适配器, 螺纹密封圈 (SVN4 和 OR)

The above data is given based on "Technical Data Sheet" DB-Nr.51080-05 for reference only. For details and the most update version, please contact our sales department for "The latest Technical Data Sheet". 以上数据来源于PMA工厂“技术数据表”DB-Nr.51080-05。因厂家会随时更新数据, 故相关数据仅供参考, 如要了解详细和最新技术资料请联系我司销售部索取《最新技术数据表》。

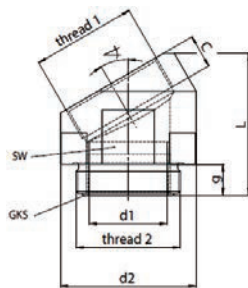

Outlet directions:
45° elbow / MAVI-Pxx/01



Outlet directions:
30° elbow / MAVI-Pxx/02
(on request)



Outlet directions:
15° elbow / MAVI-Pxx/03
(on request)

MAVIK-M

positioning, elbow adapter with various outlet angles, metric thread 定位弯曲适配器, 适合各种角度, 公制螺纹

In connection with PMA connectors, especially connectors with strain relief VNZ. For high loads. Where certain cable outlet angles are required. 与PMA管接头配合使用, 特别是VNZ系列消除应力管接头。适用于高负载场合。应用于电缆出口角度有一定要求的场合。

IP66/IP68



Order No. 订货号	Thread inside metric 内螺纹 thread 1	Thread outside metric 外螺纹 thread 2	Dimensions 尺寸					Packing unit 包装量 (pcs/PU)	MOQ 最小起订量		
			g (mm)	Ø D (mm)	01/45° L (mm)	02/30° L (mm)	03/15° L (mm)		01/45° (pcs)	02/30° (pcs)	03/15° (pcs)
# MAVIK-M20 / xx	M20x1.5	M20x1.5	10.0	35.0	52.0	49.0	43.0	10	-	10	TBA 待定
# MAVIK-M25 / xx	M25x1.5	M25x1.5	11.0	39.0	58.0	54.0	49.5	10	-	10	10
# MAVIK-M32 / xx	M32x1.5	M32x1.5	13.0	46.0	61.0	57.0	51.0	10	-	10	10
# MAVIK-M40 / xx	M40x1.5	M40x1.5	13.0	55.0	69.5	65.0	56.0	10	-	10	10
# MAVIK-M50 / xx	M50x1.5	M50x1.5	14.0	65.0	83.0	76.0	66.0	10	-	10	10
# MAVIK-M63 / xx	M63x1.5	M63x1.5	14.0	80.0	92.0	84.5	68.5	10	10	TBA 待定	TBA 待定

标记为 # 的产品有最小起订量 (MOQ)
待定 = MOQ需与工厂确认

- Adapter made from nickel-plated aluminium (other materials e.g. stainless steel or nickel plated brass available on request)
适配器由铝镀镍制成 (可根据要求提供其他材料, 如不锈钢或黄铜镀镍)
- Counter nut made from nickel-plated brass
埋头螺母由黄铜镀镍制成
- Very high impact resistance
非常高的抗冲击强度
- High thread and system connection strengths
高强度的螺纹和系统连接
- The counter nut allows accurate positioning of the outlet direction in threaded holes
埋头螺母可准确定位出口位置
- Available outlet directions:
提供各种出口角度
- 45° (MAVIK-Mxx/01)
- 30° (MAVIK-Mxx/02) on request
按需要提供
- 15° (MAVIK-Mxx/03) on request
按需要提供
- IP68 stat. / IP67 dyn.
IP68静态 / IP67动态
- Temperature range: -60°C to +105°C
温度范围: -60°C 至 +105°C
- Content of delivery: adapter, thread seal OR
包装配件: 适配器, 螺纹密封圈 OR

The above data is given based on "Technical Data Sheet" DB-Nr.51095-07 for reference only. For details and the most update version, please contact our sales department for "The latest Technical Data Sheet". 以上数据来源于PMA工厂“技术数据表”DB-Nr.51095-07。因厂家会随时更新数据, 故相关数据仅供参考, 如要了解详细和最新技术资料请联系我司销售部索取《最新技术数据表》。

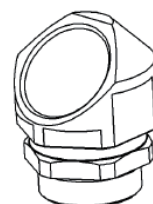
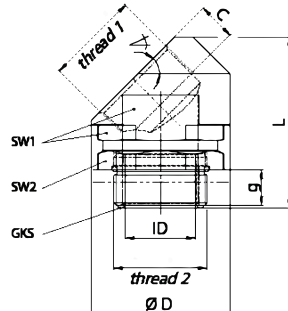

Outlet directions:
45° elbow / MAVIK-Mxx/01



Outlet directions:
30° elbow / MAVIK-Mxx/02
(auf Anfrage)

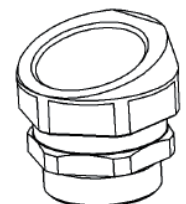

Outlet directions:
15° elbow / MAVIK-Mxx/03
(auf Anfrage)

special metal connectors for overbraided conduits, metric thread**MONV-M**

特殊金属管接头，适合带编织网软管，公制螺纹

For termination of overbraided conduits in railway vehicle construction, for high loads, for EMC shielding and in areas with hot metal shavings and flying sparks.

应用于铁路机车建设，适用于高负载场合、EMC屏蔽、高热金属刮擦和产生电火花的区域。

**IP66/IP68**

- Nickel-plated brass
黄铜镀镍制成
- Very high impact resistance
非常高的抗冲击强度
- High thread and system connection strengths
高强度的螺纹和系统连接
- Vibration-proof connection to overbraided PMAFLEX conduits
和带编织网的PMAFLEX软管连接抗震性良好
- Easy mounting with clamping nut
带夹紧螺母，安装简便
- High conduit pull-out strength
高抗拉伸强度
- Very good weather resistance
非常好的耐候性
- Free from halogens and cadmium
不含卤素和镉
- RoHS and REACH compliant
RoHS 和 REACH 合规性
- Fits both conduit profiles - fine (T) and coarse (G)
适合两种软管波纹 - 细波纹 (T) 和粗波纹 (G)
- IP68 stat. / IP67 dyn.
IP68静态 / IP67动态
- Content of delivery: Tension ring and screw, conduit seal (NVN3) and flat gasket (SVN4) and O-ring (OR)
包括配件：压力环和螺钉，软管密封圈 (NVN3) 扁平垫圈 (SVN4) 和 O型圈 (OR)

Order No. metal 订货号 金属	Thread size metric 螺纹尺寸 公制	Conduit size 软管规格 NW 标称内径 (mm)	Dimensions 尺寸			Packing unit 包装量 (pcs/PU)	MOQ 最小起订量 (pcs)
			g (mm)	L (mm)	d2 (mm)		
# MONV - M162 - 10	M16x1.5	12	10.0	57.0	26.0	1	TBA 待定
# MONV - M202 - 10	M20x1.5	12	10.0	57.0	26.0	1	10
# MONV - M207 - 10	M20x1.5	17	10.0	63.5	35.0	1	10
# MONV - M257 - 11	M25x1.5	17	11.0	64.5	35.0	1	10
# MONV - M253 - 11	M25x1.5	23	11.0	64.5	40.0	1	10
# MONV - M323 - 13	M32x1.5	23	13.0	68.5	45.0	1	10
# MONV - M329 - 13	M32x1.5	29	13.0	74.5	50.0	1	10
# MONV - M409 - 13	M40x1.5	29	13.0	74.5	50.0	1	10
# MONV - M406 - 13	M40x1.5	36	13.0	82.0	59.0	1	10
# MONV - M638 - 14	M63x1.5	48	14.0	86.5	75.0	1	10

标记为 # 的产品有最小起订量 (MOQ)
待定 = MOQ需与工厂确认

The above data is given based on "Technical Data Sheet" DB-Nr.52010-06 for reference only.

For details and the most update version, please contact our sales department for "The latest Technical Data Sheet".

以上数据来源于PMA工厂“技术数据表”DB-Nr.52010-06。因厂家会随时更新数据，故相关数据仅供参考，如要了解详细和最新技术资料请联系我司销售部索取《最新技术数据表》。

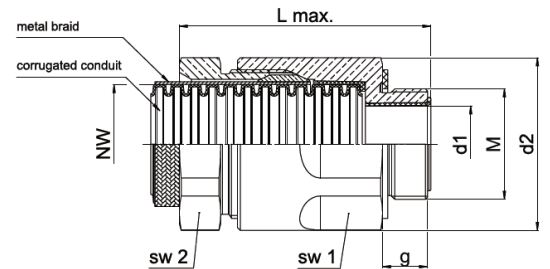

MPNK-M

metric, metal thread 公制，金属螺纹

For high temperature applications. In railway vehicle construction. For high loads. 应用于高温场合。车辆和铁路机车制造。高负载。



IP66/IP68



Order No. 订货号	Thread metric 螺纹公制	Conduit size 软管规格 NW 标称内径 (mm)	Dimensions 尺寸			Packing unit 包装量 (pcs/PU)	MOQ 最小起订量 (pcs)
			g (mm)	L (mm)	d2 (mm)		
# MPNK - M160	M16x1.5	10	12.0	33.4	24.1	1	100
MPNK - M162	M16x1.5	12	12.0	35.4	28.0	1	-
MPNK - M207	M20x1.5	17	14.0	38.3	33.0	1	-
MPNK - M253	M25x1.5	23	15.0	45.0	41.4	1	-
MPNK - M329	M32x1.5	29	18.0	52.4	48.1	1	-

标记为 # 的产品有最小起订量 (MOQ)

- Nickel-plated brass, seals are made from silicon 黄铜镀镍，密封件由硅制成
- Very high impact resistance 非常高的抗冲击强度
- High thread and system connection strengths 极高强度的螺纹和系统连接
- Vibration-proof connection to PMA conduits 配合PMA软管使用具有很好的防震作用
- Easy installation 易于安装
- High conduit pull-out strength 高强度的抗拉能力
- Very good weather resistance 非常好的耐候性
- Free from halogens and cadmium 不含卤素和镉
- RoHS and REACH compliant RoHS 和 REACH 合规性
- Temperature range: -60°C to +260°C stat. / -45°C to +260°C dyn. 温度范围：-60°C 至 +260°C (静态) / -45°C 至 +260°C (动态)
- Content of delivery: metal connector, conduit sealing ring, thread gasket (SVN4) and o-ring (two alternatives) 包括配件：金属管接头，软管密封圈，螺纹垫圈(SVN4)和O型圈（两种选择）

The above data is given based on "Technical Data Sheet" DB-Nr.52200-03 for reference only. For details and the most update version, please contact our sales department for "The latest Technical Data Sheet". 以上数据来源于PMA工厂“技术数据表”DB-Nr.52200-03。因厂家会随时更新数据，故相关数据仅供参考，如要了解详细和最新技术资料请联系我司销售部索取《最新技术数据表》。

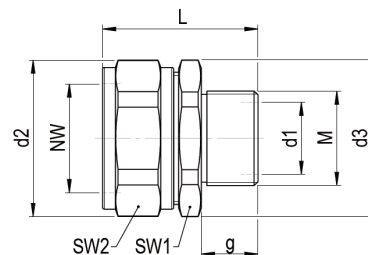

metric, metal thread 公制，金属螺纹

MONK-M

For termination of overbraided corrugated conduits. For high temperature applications. In railway vehicle construction. For high loads. In areas with metal shavings and flying sparks.

金属管接头，用于外包编织网管的软管。应用于高温场合。应用于铁路机车建设。适用于高负载场合。适用于高热金属刮擦和产生电火花区域。



IP66/IP68



Order No. 订货号	Thread metric 螺纹公制	Conduit size 软管规格 NW 标称内径 (mm)	Dimensions 尺寸					Packing unit 包装量 (pcs/PU)	MOQ 最小起订量 (pcs)
			E (mm)	J (mm)	ØA (mm)	ØB (mm)	ØC (mm)		
MONK - M162	M16x1.5	12	12.0	46.0	15.8	17.2	12.0	1	-
MONK - M207	M20x1.5	17	14.0	50.0	21.2	23.6	16.0	1	-
# MONK - M257	M25x1.5	17	12.0	51.0	21.2	23.6	19.0	1	10
MONK - M253	M25x1.5	23	15.0	55.0	28.5	30.0	19.0	1	-
MONK - M329	M32x1.5	29	18.0	62.0	34.5	36.0	26.5	1	-
MONK - M406	M40x1.5	36	15.0	80.0	42.4	44.5	35.0	1	-
MONK - M508	M50x1.5	48	16.0	85.0	54.4	57.0	45.0	1	-

标记为 # 的产品有最小起订量 (MOQ)

The above data is given based on "Technical Data Sheet" DB-Nr.52210-02 for reference only. For details and the most update version, please contact our sales department for "The latest Technical Data Sheet". 以上数据来源于PMA工厂“技术数据表”DB-Nr.52210-02。因厂家会随时更新数据，故相关数据仅供参考，如要了解详细和最新技术资料请联系我司销售部索取《最新技术数据表》。

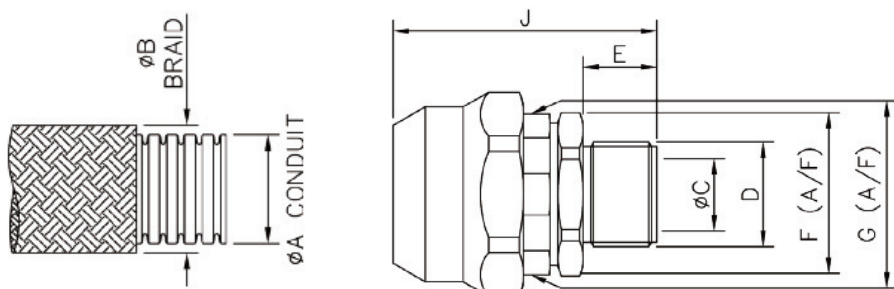

- Nickel-plated brass, seals are made from silicon 黄铜镀镍，密封件由硅制成
- Very high impact resistance 非常高的抗冲击强度
- High thread and system connection strengths 极高强度的螺纹和系统连接
- Vibration-proof connection to PMA conduits 配合PMA软管使用具有很好的防震作用
- Easy installation 易于安装
- High conduit pull-out strength 高强度的抗拉能力
- Very good weather resistance 非常好的耐候性
- Temperature range: -60°C to +260°C stat. / -45°C to +260°C dyn. 温度范围：-60°C 至 +260°C (静态) / -45°C 至 +260°C (动态)
- Content of delivery: metal connector, conduit sealing ring, thread gasket and o-ring (two alternatives) 包括配件：金属管接头，软管密封圈，螺纹垫圈和O型圈（两种选择）

VSGD connection splices for flexible conduits 软管连接管接头**VSGR** For cable protection systems in a wide range of applications. 在电缆保护系统中被广泛地应用。**IP66 & IP66/IP68**

Order No. IP66 订货号 IP66	Order No. IP68 订货号 IP68	Conduit size 软管规格 NW 标称内径 (mm)	Dimensions 尺寸		Packing unit 包装量 (pcs/PU)	MOQ 最小起订量	
			L (mm)	d2 (mm)		IP66 灰色S (pcs)	IP68 灰色S (pcs)
# * VSGD - 1212GT	# * VSGR - 1212	12	66.0	23.5	50	800	800
# * VSGD - 1717GT	# * VSGR - 1717	17	87.0	29.5	50	500	500
# * VSGD - 2323GT	# * VSGR - 2323	23	103.0	37.0	30	360	360
# * VSGD - 2929GT	# * VSGR - 2929	29	100.0	44.0	20	320	320
# * VSGD - 3636GT	# * VSGR - 3636	36	130.0	53.5	10	200	200
# * VSGD - 4848GT	# * VSGR - 4848	48	133.0	66.0	10	180	180

* = Replace with "B" to order black or "S" to order grey "B" 订黑色或 "S" 订灰色

标记为 # 的产品有最小起订量 (MOQ)

The above data is given based on "Technical Data Sheet" DB-Nr.23093-05/23090-07 for reference only.

For details and the most update version, please contact our sales department for "The latest Technical Data Sheet".

以上数据来源于PMA工厂“技术数据表”DB-Nr.23093-05/23090-07。因厂家会随时更新数据，故相关数据仅供参考，如要了解详细和最新技术资料请联系我司销售部索取《最新技术数据表》。

- High-grade, specially formulated polyamide 6 高级，特殊配方聚酰胺6
- Very high impact resistance 非常高的抗冲击强度
- Vibration-proof connection to PMAFLEX conduits 配合PMAFLEX软管使用具有很好的防震作用
- Easy installation: simple push fit assembly 易于安装：推入式的简易安装
- High conduit pull-out strength 高强度的抗拉能力
- Can be easily re-opened with a screwdriver 可以很容易地用螺丝刀多次开启
- Very good chemical properties 非常好的化学性能
- Free from halogens and cadmium 不含卤素和镉
- RoHS and REACH compliant RoHS 和 REACH 合规性
- Very good UV resistance and weathering characteristics, particularly in black 非常好的抗紫外线和耐候性能，尤其是黑色
- EN 45545-2 HL3 (R22 & R23) HL3. 根据EN45545-2车内软管R22 / 车外软管R23标准
- NFPA 130 NFPA 130
- UL 94 (V0): UL 1696 (UL file E80294) UL 94 (V0): UL 1696 (UL 文件 E80294)
- Fits both conduit profiles - fine (T) and coarse (G) 适用软管类型-细波纹 (T) 和粗波纹 (G)
- Temperature range: -50°C to +105°C; short-term: +160°C 温度范围: -50°C 至 +105°C; 短期温度: +160°C
- Content of delivery: 包装配件:
IP66: connection splice with pre-installed universal safety clips (AFN2) IP66: 带预装通用安全夹子 (AFN2) 的管接头
IP68: connection splice with oval clips (OVN2), conduit seal (NVN3) IP68: 管接头和椭圆型夹子 (OVN2), 软管密封圈 (NVN3)

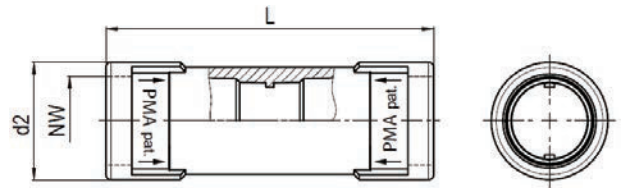

straight, connection to solid teal tube metric

直型, 连接公制尺寸钢管的管接头

In railway vehicle construction and other applications where metric metal tubes are to be connected with the flexible PMA conduits.

在铁路车辆制造及其他应用中把公制金属管与PMA软管连接。

**VNR-REM****IP66/IP68**

Order No. ▲ without jubilee clip black 订货号 不带夹子 黑色	Order No. ▲ with clamp clip black 订货号 带夹子 黑色	Steel tube metric 钢管 公制 尺寸	Conduit size 软管规格 NW 标称内径 (mm)	Dimensions 尺寸			Packing unit 包装量 (pcs/PU)	MOQ 最小起订量	
				L (mm)	d1 (mm)	d2 (mm)		without jubilee clip 不带夹子 (pcs)	with jubilee clip 带夹子 (pcs)
BVNR-REM162	BVNR-REM162-24	M16	12	54.0	16.0	23.5	50	-	-
# BVNR-REM187	# BVNR-REM187-28	M18	17	65.0	18.5	30.0	50	800	800
BVNR-REM207	BVNR-REM207-28	M20	17	65.0	20.0	30.0	50	-	-
# BVNR-REM253	# BVNR-REM253-32	M25	23	71.0	26.0	37.0	30	30	-
BVNR-REM329	BVNR-REM329-44	M32	29	71.0	32.0	44.0	20	-	-
BVNR-REM406	BVNR-REM406-50	M40	36	90.0	40.0	53.5	20	-	-
BVNR-REM508	BVNR-REM508-65	M50	48	90.0	50.0	66.0	10	-	-

标记为 # 的产品有最小起订量 (MOQ)

- High-grade, specially formulated polyamide 6, jubilee clip made of galvanised bright steel
高级, 特殊配方聚酰胺6制成. 夹子由镀锌钢制成
- Very high impact resistance
非常高的抗冲击强度
- Quick connection of solid metal tubes with flexible PMA conduits
快速灵活的连接硬的金属管和PMA软管
- Vibration-proof connection to PMA conduits
配合PMA软管使用具有很好的防震作用
- Easy installation
易于安装
- Available with or without jubilee clip
可带或不带夹子
- High conduit pull-out strength
高强度的抗拉能力
- Very good chemical properties
非常好的化学性能
- Free from halogens and cadmium
不含卤素和镉
- RoHS and REACH compliant
RoHS 和 REACH 合规性
- Very good UV resistance and weathering characteristics
非常好的抗紫外线和耐候性能
- EN 45545-2 HL3 (R22 & R23)
HL3. 根据EN45545-2车内软管R22/车外软管R23标准
- NFPA 130
NFPA 130
- UL 94 (V0)
UL 94 (V0)
- Fits both conduit profiles - fine (T) and coarse (G)
适用软管类型-细波纹 (T) 和粗波纹 (G)
- Temperature range: -50°C to +105°C; short-term: +160°C
温度范围: -50°C 至 +105°C; 短期温度: +160°C

Content of delivery:

- 包装配件:
- IP68: fitting with oval clips (OVN2), conduit seal (NVN3), clamp according to order number
管接头和椭圆形夹子 (OVN2), 密封圈 (NVN3), 夹子依照订单号
 - IP68GT: fitting with pre-assembled universal safety clips (AFN2) and conduit seal (NVN3-GT); clamp according to order no.
带预装通用安全夹子 (AFN2) 和软管密封圈 (NVN3-GT) 的管接头; 夹子依照订单号

▲ IP68GT available. Please add "GT" to order no. or insert before clamp size (e.g. BVNR-REM162GT, BVNR-REM162GT24).
(Functional description PMAFIX IP68GT, page 3-11/12/13).

IP68GT管接头开始供应。请在订货号加上"GT"。或插在管夹尺寸的前面。(例如: BVNR-REM162GT, BVNR-REM162GT24)。(有关PMAFIX IP68GT管接头的功能描述, 见P3-11/12/13)。

The above data is given based on "Technical Data Sheet" DB-Nr.42030-06 for reference only.

For details and the most update version, please contact our sales department for "The latest Technical Data Sheet".

以上数据来源于PMA工厂“技术数据表”DB-Nr.42030-06。因厂家会随时更新数据, 故相关数据仅供参考, 如要了解详细和最新技术资料请联系我司销售部索取《最新技术数据表》。

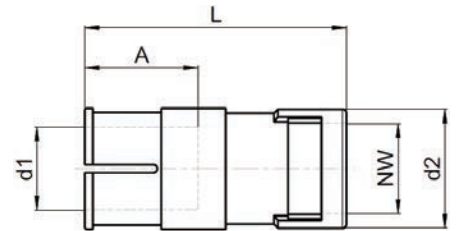

VNR - RE

straight, connection to solid steel tube PG/inch
直型, 连接PG / 英制钢管的管接头

In railway vehicle with PG dimensions construction and other applications where metal tubes are to be connected with the flexible PMAFLEX system.
在铁路车辆制造及其他应用中把PG制金属管与PMAFLEX软管连接。



IP66/IP68



- High-grade, specially formulated polyamide 6, jubilee clip made of galvanised bright steel
高级, 特殊配方聚酰胺6制成, 夹子由镀锌钢制成
- Very high impact resistance
非常高的抗冲击强度
- Quick connection of solid metal tubes with flexible PMA conduits
快速灵活的连接硬的金属管和PMA软管
- Vibration-proof connection to PMA conduits
配合PMA软管使用具有很好的防震作用
- Available with or without jubilee clip
可带或不带夹子
- Easy installation
易于安装
- High conduit pull-out strength
高强度的抗拉能力
- Very good chemical properties
非常好的化学性能
- Free from halogens and cadmium
不含卤素和镉
- RoHS and REACH compliant
RoHS 和 REACH 合规性
- Very good UV resistance and weathering characteristics
非常好的抗紫外线和耐候性能
- EN 45545-2 HL3 (R22 & R23)
HL3, 根据EN45545-2车内软管R22 / 车外软管R23标准
- NFPA 130
NFPA 130
- UL 94 (V0)
UL 94 (V0)
- Fits both conduit profiles - fine (T) and coarse (G)
适用软管类型-细波纹 (T) 和粗波纹 (G)
- Temperature range: -50°C to +105°C; short-term: +160°C
温度范围: -50°C 至 +105°C; 短期温度: +160°C
- Content of delivery:
包装配件:
IP68: fitting with oval clips (OVN2), conduit seal (NVN3), clamp according to order number
IP68: 管接头和椭圆形夹子 (OVN2), 密封圈 (NVN3), 夹子依照订单号
IP68GT: fitting with pre-assembled universal safety clips (AFN2) and conduit seal (NVN3-GT); clamp according to order no.
IP68GT: 带预装通用安全夹子 (AFN2) 和软管密封圈 (NVN3-GT) 的管接头; 夹子依照订单号

Order No. ▲ without jubilee clip black 订货号 不带夹子 黑色	Order No. ▲ with clamp clip black 订货号 带夹子 黑色	Metal tube PG / inch 钢管 PG/ 英制尺寸	Conduit size 软管规格 NW 标称内径 (mm)	Dimensions 尺寸			Packing unit 包装量 (pcs/PU)	MOQ 最小起订量	
				L (mm)	d1 (mm)	d2 (mm)		without jubilee clip 不带夹子 (pcs)	with jubilee clip 带夹子 (pcs)
# BVNR-RE12	# BVNR-RE12-24	PG11	12	54.0	18.5	26.0	50	600	600
BVNR-RE1317	BVNR-RE1317-28	PG13	17	65.0	20.4	30.0	50	-	-
BVNR-RE17	BVNR-RE17-28	PG16	17	65.0	22.5	30.0	50	-	-
BVNR-RE23	BVNR-RE23-32	PG21	23	71.0	28.3	37.0	30	-	-
BVNR-RE29	BVNR-RE29-44	PG29	29	70.5	37.0	45.0	20	-	-
BVNR-RE36	BVNR-RE36-50	PG36	36	84.5	47.0	56.0	20	-	-
BVNR-RE48	BVNR-RE48-65	PG48	48	90.0	59.3	67.5	10	-	-
# BVNR-RE1917	-	3/4"	17	65.0	19.0	29.5	50	800	-
# BVNR-RE2523	-	1"	23	71.0	25.5	37.0	30	600	-
# BVNR-RE3129	-	1 1/4"	29	71.0	32.0	44.0	10	600	-
# BVNR-RE3836	-	1 1/2"	36	130.0	38.0	53.5	10	400	-

标记为 # 的产品有最小起订量 (MOQ)

- ▲ IP68GT available. Please add "GT" to order no. or insert before clamp size (e.g. BVNR-REM12GT, BVNR-REM12GT24). (Functional description PMAFIX IP68GT, page 3-11/12/13).
IP68GT管接头开始供应。请在订货号加上"GT"。或插在管夹尺寸的前面。(例如: BVNR-REM12GT, BVNR-REM12GT24)。(有关PMAFIX IP68GT管接头的功能描述, 见P3-11/12/13)。
The above data is given based on "Technical Data Sheet" DB-Nr.42020-11 for reference only.
For details and the most update version, please contact our sales department for "The latest Technical Data Sheet".
以上数据来源于PMA工厂“技术数据表”DB-Nr.42020-11。因厂家会随时更新数据, 故相关数据仅供参考, 如要了解详细和最新技术资料请联系我司销售部索取《最新技术数据表》。

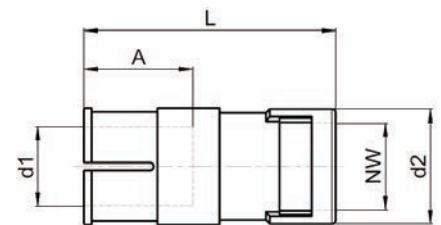

AVD

conduit enlarger

软管增扩器

AVR

In connection with PMA conduit / fitting system.

应用在PMA系列的软管和管接头的连接。



IP66 & IP66/IP68



- High-grade, specially formulated polyamide 6
高级特殊配方聚酰胺6制成
- Very high impact resistance
非常高的抗冲击强度
- Allows variable application of the PMAFIX system particularly of PMA distribution pieces
此类适配器适合改变PMAFIX管径，特别是PMA三通管接头
- Easy installation
易于安装
- Can be easily re-opened with a screwdriver
可以很容易地用螺丝刀多次开启
- High conduit pull-out strength
高强度的抗拉能力
- Very good chemical properties
非常好的化学性能
- Free from halogens and cadmium
不含卤素和镉
- RoHS and REACH compliant
RoHS 和 REACH 合规性
- Very good UV resistance and weathering characteristics, particularly in black
非常好的抗紫外线和耐候性能，尤其是黑色
- EN 45545-2 HL3 (R22 & R23)
HL3, 根据EN45545-2车内软管R22 / 车外软管 R23 标准
- NFPA 130
- UL 94 (V0); UL 1696 (UL file E80294)
UL 94 (V0); UL 1696 (UL 文件 E80294)
- Fits both conduit profiles - fine (T) and coarse (G)
适用软管类型-细波纹 (T) 和粗波纹 (G)
- Temperature range: -50°C to +105°C; short-term: +160°C
温度范围: -50°C 至 +105°C; 短期温度: +160°C
- Content of delivery:
包装配件:
IP66: adapter with pre-assembled universal safety clips (AFN2)
IP66: 带预装通用安全夹子 (AFN2) 的管接头
IP68: adapter with oval clips (OVN2), conduit seal (NVN3)
IP68: 管接头和椭圆型夹子 (OVN2), 软管密封圈 (NVN3)

Order No. IP66 订货号 IP66	Order No. IP68 订货号 IP68	Conduit size 软管规格 NW 标称内径 NW (A) NW (B)		Dimensions 尺寸 L d2 (mm) (mm)		Packing unit 包装量 (pcs/PU) IP68 IP68		MOQ 最小起订量 IP66 灰色S (pcs) IP68 灰色S (pcs)	
		-	* AVR-10/07	10	07	43.0	16.5	-	50
** AVD-12/10GT	** AVR-12/10	12	10	46.0	20.0	50	50	800	500
** AVD-17/10GT	** AVR-17/10	17	10	53.0	20.0	50	50	TBA 待定	500
** AVD-17/12GT	** AVR-17/12	17	12	54.0	23.5	50	50	800	400
** AVD-23/10GT	** AVR-23/10	23	10	54.0	20.0	30	30	TBA 待定	600
** AVD-23/12GT	** AVR-23/12	23	12	53.0	23.5	30	30	600	600
* AVD-23/17GT	** AVR-23/17	23	17	62.0	29.5	30	30	-	360
** AVD-29/10GT	** AVR-29/10	29	10	56.5	20.0	30	20	TBA 待定	400
** AVD-29/12GT	** AVR-29/12	29	12	55.0	23.5	30	20	TBA 待定	450
** AVD-29/17GT	** AVR-29/17	29	17	61.0	29.5	30	20	TBA 待定	320
** AVD-29/23GT	** AVR-29/23	29	23	64.0	37.0	30	20	360	300
** AVD-36/29GT	** AVR-36/29	36	29	81.0	44.0	20	20	200	160
** AVD-48/36GT	** AVR-48/36	48	36	88.5	53.5	10	10	150	160

标记为 # 的产品有最小起订量 (MOQ)
待定 = MOQ需与工厂确认

* = Replace with "B" to order black or "S" to order grey "B" 订黑色或 "S" 订灰色

The above data is given based on "Technical Data Sheet" DB-Nr.40039-08 / 40040-11 for reference only.

For details and the most update version, please contact our sales department for "The latest Technical Data Sheet".

以上数据来源于PMA工厂“技术数据表”DB-Nr.40039-08 / 40040-11。因厂家会随时更新数据，故相关数据仅供参考，如要了解详细和最新技术资料请联系我司销售部索取《最新技术数据表》。

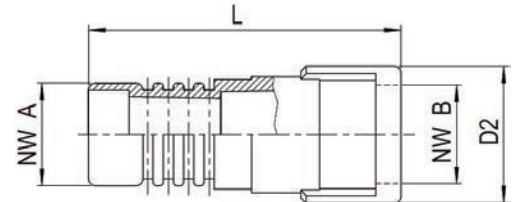

FAD *conduit adapter* 软管适配器

Can be used as a transition piece for mounting conduits with a smaller diameter than the fitting is designed for.
配合原有管接头，作为安装口径较小的软管适配器。



IP50



- High-grade, specially formulated polyamide 6
高级特别配方聚酰胺6
- Conduit enlarger
软管增扩器
- Very high impact resistance
非常高的抗冲击强度
- Very good chemical properties
非常好的化学性能
- Free from halogens and cadmium
不含卤素和镉
- RoHS and REACH compliant
RoHS 和 REACH 合规性
- Very good UV resistance and weathering characteristics
非常好的抗紫外线和耐候性能
- Temperature range: -50°C to +105°C; short-term: +160°C
温度范围: -50°C 至 +105°C; 短期温度: +160°C

Order No. black 订货号 黑色	Conduit size 软管规格 NW 标称内径		Dimensions 尺寸				Packing unit 包装量 (pcs/PU)
	NW (A)	NW (B)	L (mm)	d2 (mm)	NW1 (mm)	NW2 (mm)	
BFAD - P070	07	10	20.0	14.0	10.2	13.2	50
BFAD - P102	10	12	20.0	16.5	13.2	16.5	50
BFAD - P127	12	17	20.0	22.5	16.5	21.0	50

The above data is given based on "Technical Data Sheet" DB-Nr.40041-02 for reference only.
For details and the most update version, please contact our sales department for "The latest Technical Data Sheet".
以上数据来源于PMA工厂“技术数据表”DB-Nr.40041-02。因厂家会随时更新数据，故相关数据仅供参考，如要了解详细和最新技术资料请联系我司销售部索取《最新技术数据表》。

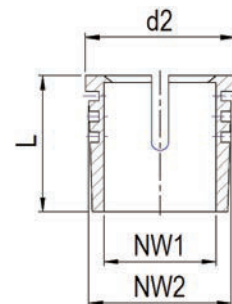

RKS *conduit terminal sleeves* 终端套管

Used at the end of conduits where no connectors with threads are necessary. 应用于无需螺纹连接的软管末端，是一种特有的套管。



- High-grade, specially formulated polyamide 6
高级特别配方聚酰胺6
- Cylindrical design
采用圆柱形的设计
- Clean conduit end termination
应用在软管的末端，使得软管末端更加平滑
- Very good chemical properties
非常好的化学性能
- Free from halogens and cadmium
不含卤素和镉
- RoHS and REACH compliant
RoHS 和 REACH 合规性
- Very good UV resistance and weathering characteristics
非常好的抗紫外线和耐候性能
- EN 45545-2 HL3 (R22 & R23)
HL3, 根据EN45545-2车内软管R22/车外软管R23标准
- NFPA 130
NFPA 130
- UL 94 (V0)
UL 94 (V0)
- Fits both conduit profiles - fine (T) and coarse (G)
适用软管类型-细波纹 (T) 和粗波纹 (G)
- Temperature range: -50°C to +105°C; short-term: +160°C
温度范围: -50°C 至 +105°C; 短期温度: +160°C

Order No. black 订货号 黑色	Conduit size 软管规格 NW 标称内径 (mm)	Dimensions 尺寸			Packing unit 包装量 (pcs/PU)
		L (mm)	d1 (mm)	d2 (mm)	
RKS - 07	07	16.0	4.5	12.5	100
RKS - 10	10	16.0	8.0	15.5	100
RKS - 12	12	20.0	10.0	19.0	100
RKS - 17	17	21.0	13.0	24.0	100
RKS - 23	23	22.0	20.0	32.0	50
RKS - 29	29	22.0	25.0	38.0	30
RKS - 36	36	25.0	33.0	46.0	20
RKS - 48	48	25.0	45.0	58.0	10
RKS - 56	56	28.0	54.0	71.0	10

The above data is given based on "Technical Data Sheet" DB-Nr.40200-06 for reference only.
For details and the most update version, please contact our sales department for "The latest Technical Data Sheet".
以上数据来源于PMA工厂“技术数据表”DB-Nr.40200-06。因厂家会随时更新数据，故相关数据仅供参考，如要了解详细和最新技术资料请联系我司销售部索取《最新技术数据表》。

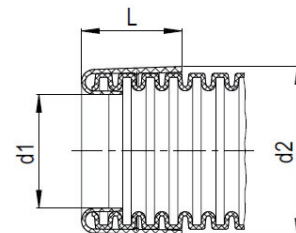

CT

conduit termination 软管终端

For sealing of cables and wires at the exit from PMA corrugated conduits. 用于在软管末端电线的密封应用。

CE



Order No. black 订货号 黑色	Conduit size 软管规格 NW 标称内径 (mm)	Dimensions 尺寸		Clamping Range 电缆直径 (mm)	Packing unit 包装量 (pcs/PU)
		A (mm)	B (mm)		
BCT-10	10	13.0	28.0	4 - 6	10
BCT-12	12	16.0	35.0	5 - 9	10
BCT-17	17	21.0	42.0	7 - 14	10
BCT-23	23	28.0	51.0	14 - 22	10
BCT-29	29	34.0	53.0	16 - 22	10
BCT-36	36	42.0	55.0	16 - 29	10

- Neoprene rubber
由氯丁橡胶制成
- Avoids ingress of dirt and liquids
避免灰尘和液体的侵入
- Large clamping range at the exit enables a wide range of applications
出口处的电缆夹紧范围广泛
- Can be fixed additionally with cable ties
可用电缆扎带加强固定
- Good electrical insulation
良好的电气绝缘性
- Free from halogens and cadmium
不含卤素和镉
- RoHS and REACH compliant
RoHS 和 REACH 合规性
- Temperature range: -30°C to +120°C
温度范围: -30°C 至 +120°C

The above data is given based on "Technical Data Sheet" DB-Nr.60550-01 for reference only.

For details and the most update version, please contact our sales department for "The latest Technical Data Sheet".

以上数据来源于PMA工厂“技术数据表”DB-Nr.60550-01。因厂家会随时更新数据，故相关数据仅供参考，如要了解详细和最新技术资料请联系我司销售部索取《最新技术数据表》。

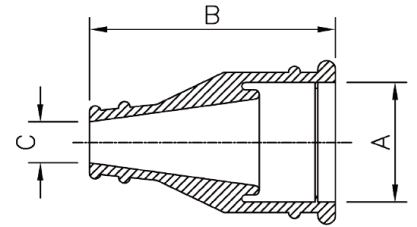

SS/SV

abrasion protection sleeves 防磨损套管

Abrasion protection for corrugated conduits in position exposed to chafing. 用于不同场所对波纹软管的防磨损保护。

CE



Order No. black 订货号 黑色	Conduit size 软管规格 NW 标称内径 (mm)	Dimensions 尺寸		Packing unit 包装量 (pcs/PU)	MOQ 最小起订量
		d2 (mm)	A (mm)		黑色 (pcs)
# BSS-10	10	30.0	18.0	100	100
# BSS-12	12	33.0	20.0	50	50
BSS-17	17	42.0	22.0	50	-
BSS-23	23	49.0	26.0	30	-
BSS-29	29	55.0	26.0	20	-
BSS-36	36	63.0	30.0	20	-
BSS-48	48	75.0	30.0	10	-
BSS-56G	56	90.0	33.0	10	-
BSV-70G	70	108.0	60.0	10	-

标记为 # 的产品有最小起订量 (MOQ)

The above data is given based on "Technical Data Sheet" DB-Nr.40225-06 / 40220-03 for reference only.

For details and the most update version, please contact our sales department for "The latest Technical Data Sheet".

以上数据来源于PMA工厂“技术数据表”DB-Nr.40225-06 / 40220-03。因厂家会随时更新数据，故相关数据仅供参考，如要了解详细和最新技术资料请联系我司销售部索取《最新技术数据表》。

- High-grade, specially modified polyamide 6
高级，特殊改良聚酰胺6制成
- Increased the life time of moving conduits
延长动态软管的使用寿命
- Excellent chafing characteristics
极好的防磨特性
- Very good chemical properties
非常好的化学性能
- Free from halogens and cadmium
不含卤素和镉
- RoHS and REACH compliant
RoHS 和 REACH 合规性
- Very good UV resistance and weathering characteristics
非常好的抗紫外线和耐候性能
- EN 45545-2 HL3 (R22 & R23)
HL3, 根据EN45545-2车内软管R22 / 车外软管R23标准
- NFPA 130
NFPA 130
- UL 94 (V0)
UL 94 (V0)
- Fits both conduit profiles-fine (T) and coarse (G)
适用软管类型-细波纹 (T) 和粗波纹 (G)
- Temperature range: -50°C to +105°C; short-term: +160°C
温度范围: -50°C 至 +105°C; 短期温度: +160°C
- Content of delivery: abrasion protection sleeves,
BSS: 2 pcs. PT-screws KA 35 x 14;
BSV: 4 pcs. PT-screws KA 50 x 16
包括配件: 防摩擦套管, BSS: 2个 PT-螺钉 KA 35 x 14;
BSV: 4个 PT-螺钉 KA 50 x 16

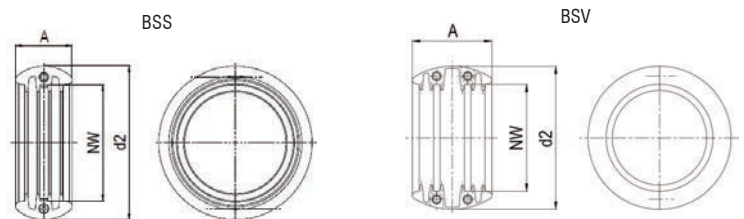

SS-0S

screwless abrasion protection sleeve 无螺钉式防磨损套管

Screwless abrasion protection for corrugated conduits in positions exposed to chafing.
无螺钉式防磨损套管应用于波纹管易磨损的位置。



Order No. black 订货号 黑色	Conduit size 软管规格 NW 标称内径 (mm)	Dimensions 尺寸		Packing unit 包装量 (pcs/PU)
		d2 (mm)	NW2 (mm)	
BSS-36-0S	36	63.0	30.0	20
BSS-48-0S	48	75.0	30.0	10
BSS-70-0S	70	104.0	44.0	10

The above data is given based on "Technical Data Sheet" DB-Nr.40235-00 for reference only.

For details and the most update version, please contact our sales department for "The latest Technical Data Sheet".

以上数据来源于PMA工厂“技术数据表”DB-Nr.40235-00。因厂家会随时更新数据，故相关数据仅供参考，如要了解详细和最新技术资料请联系我司销售部索取《最新技术数据表》。

- High-grade, specially formulated polyamide 6
高级特别配方聚酰胺6
- Increases lifetime of moving conduits in dynamic applications
延长动态软管的使用寿命
- Optimized for high impact resistance
高抗冲击强度
- No metal parts, no screws
无金属零件，无螺钉
- Tool-free installation
无需工具安装
- Easy (re-) positioning without full disassembly
无需完全拆卸即可轻松（重新）定位
- Excellent chafing characteristics
极好的防磨特性
- Free from halogens and cadmium
不含卤素和镉
- RoHS and REACH compliant
RoHS 和 REACH 合规性
- Very good UV resistance and weathering characteristics
非常好的抗紫外线和耐候性能
- Fits both conduit profiles - fine (T) and coarse (G)
适用软管类型 - 细波纹 (T) 和粗波纹 (G)
- Temperature range: -50°C to +105°C; short-term: +160°C
温度范围: -50°C 至 +105°C; 短期温度: +160°C

